

# PERFORMANCE DATA

## Contact Resistance

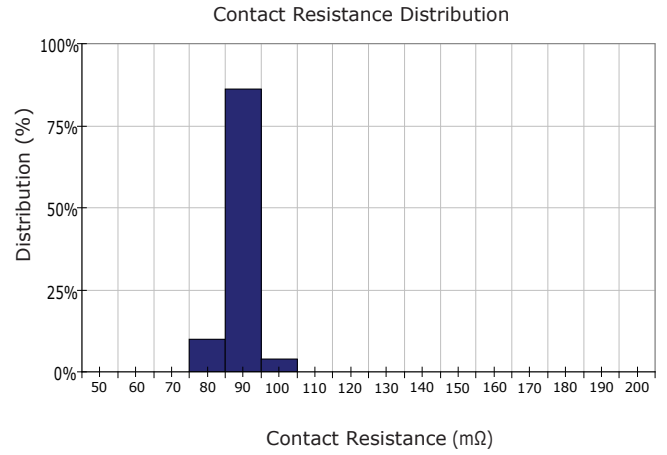

## Carry Current

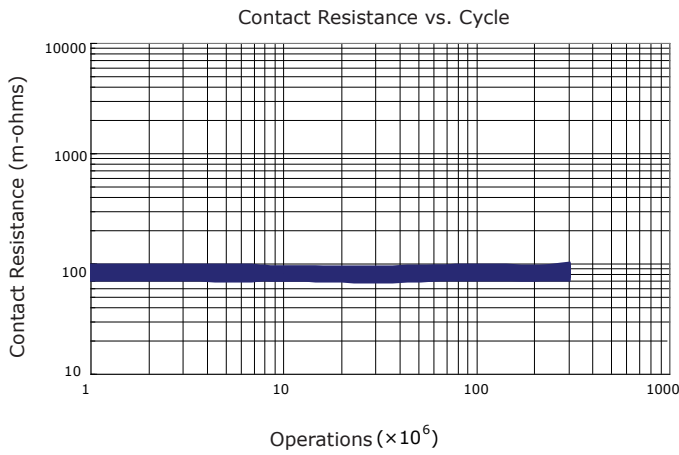
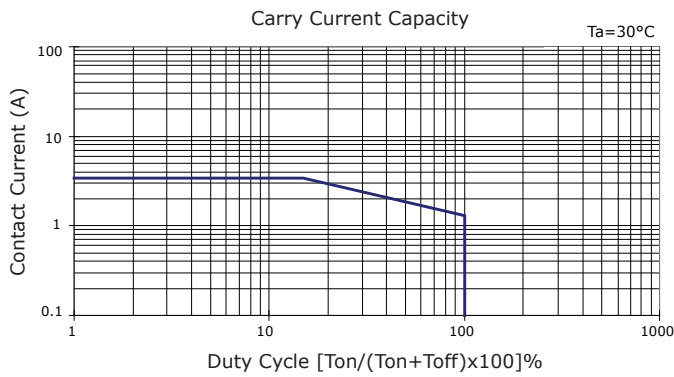

## Life

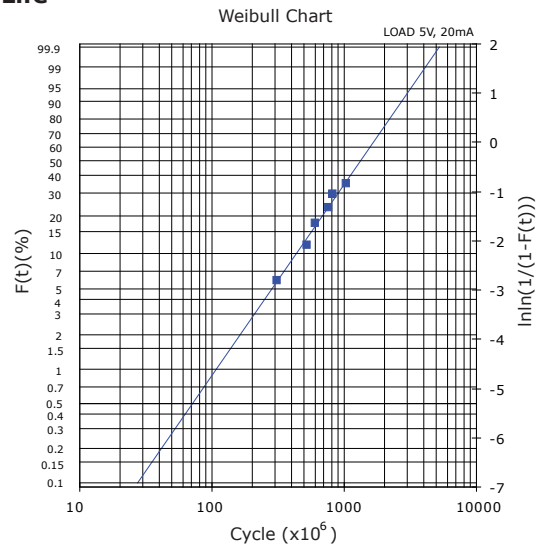

## Coil Temperature Rise

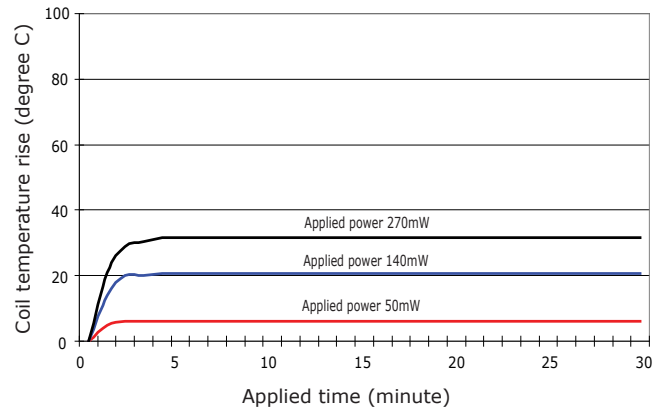
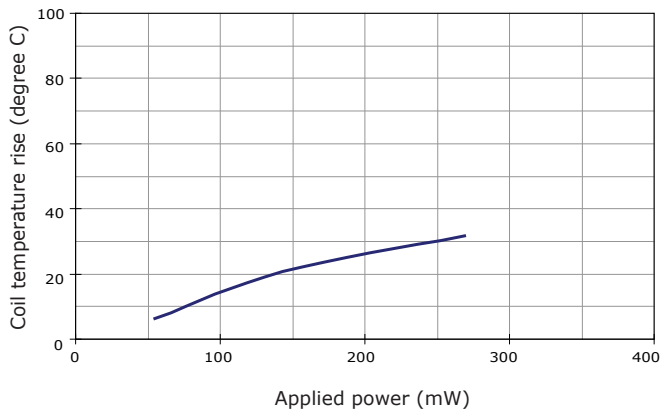

Notes: Reference data of MSG-105AK3H

## Operate and Release Voltage

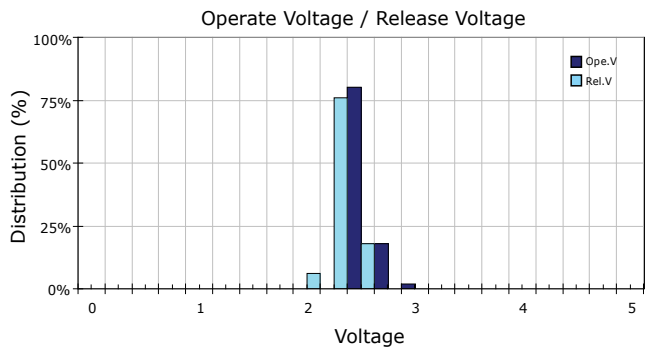
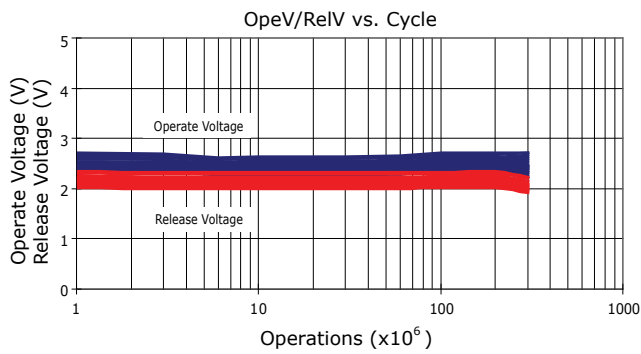
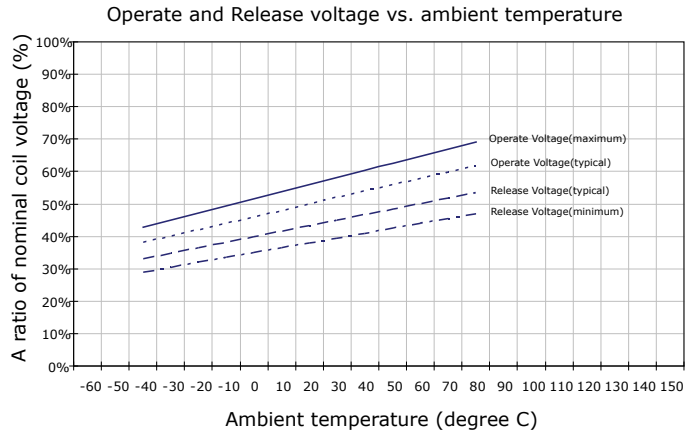

## Magnetic Interference

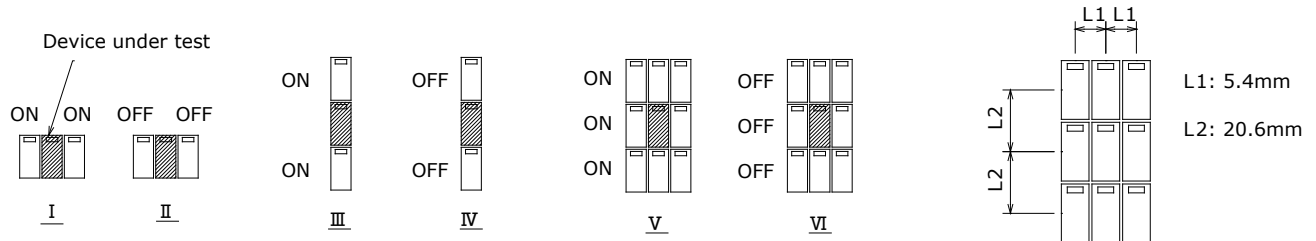
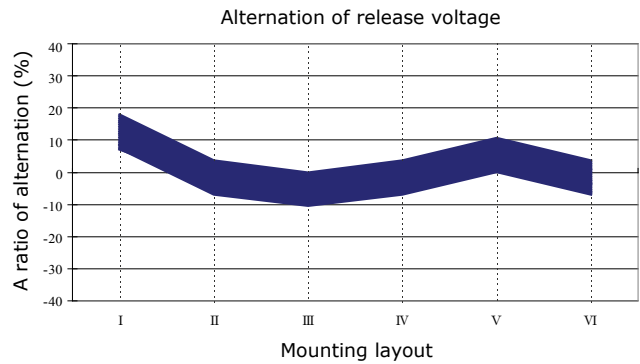
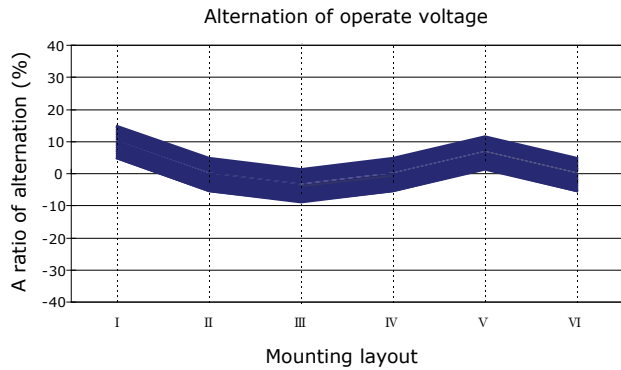

Notes: Reference data of MSG-105AK3H