

PERFORMANCE DATA

Contact Resistance

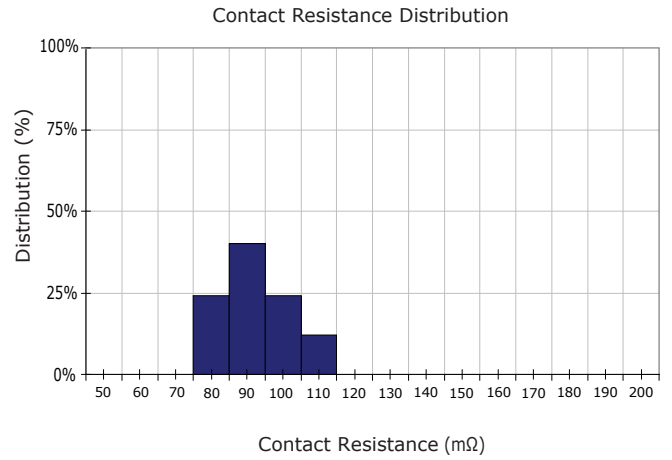

Carry Current

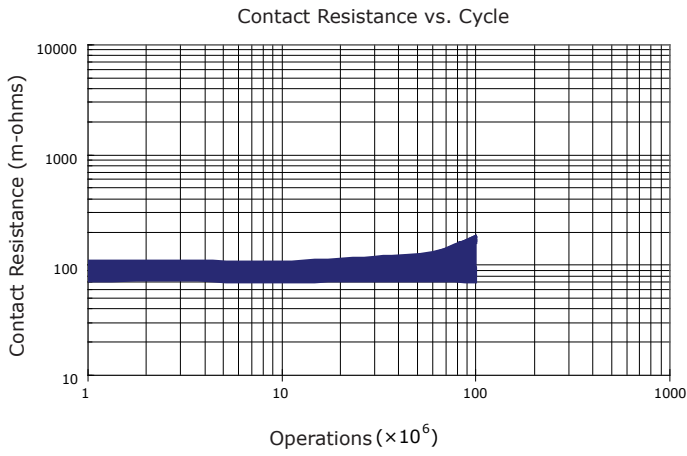
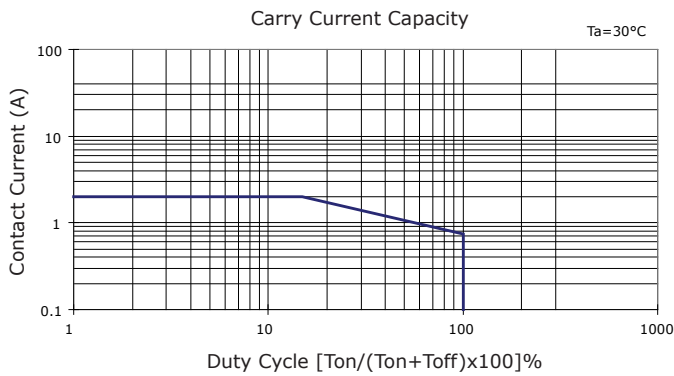

Life

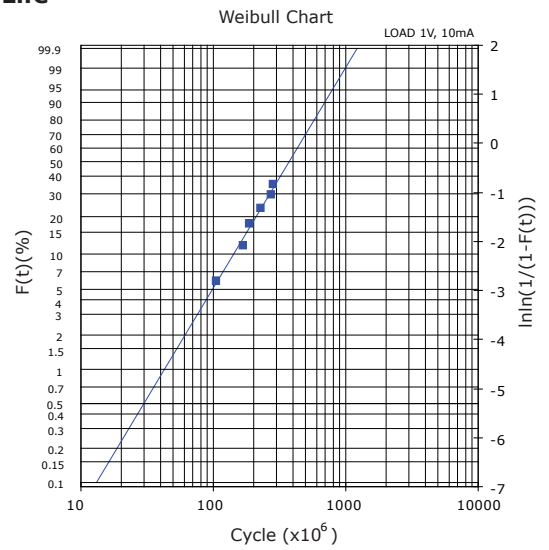

Coil Temperature Rise

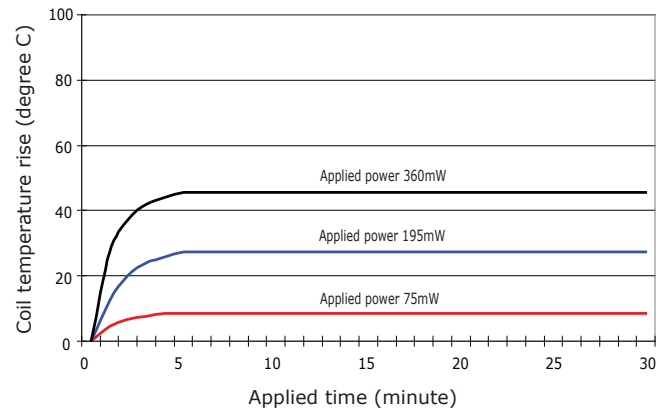
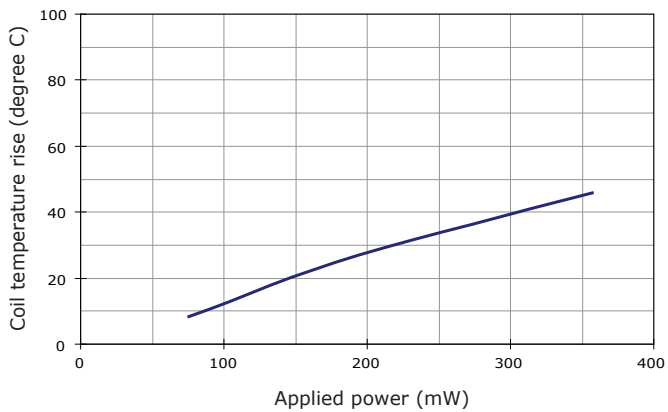

Notes: Reference data of MH-E1T05JH

Operate and Release Voltage

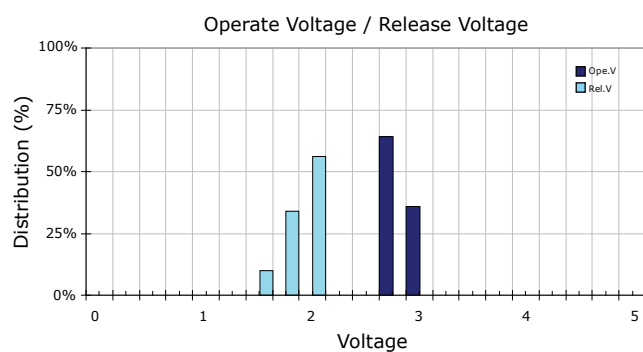
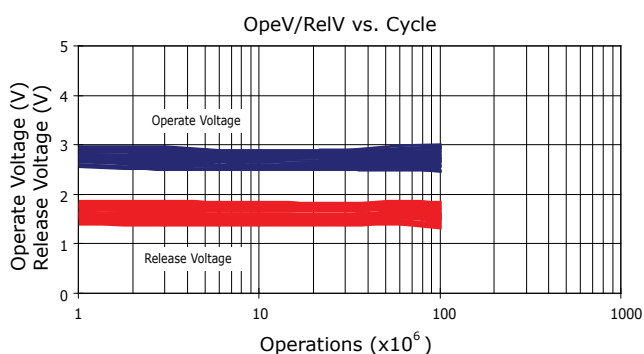
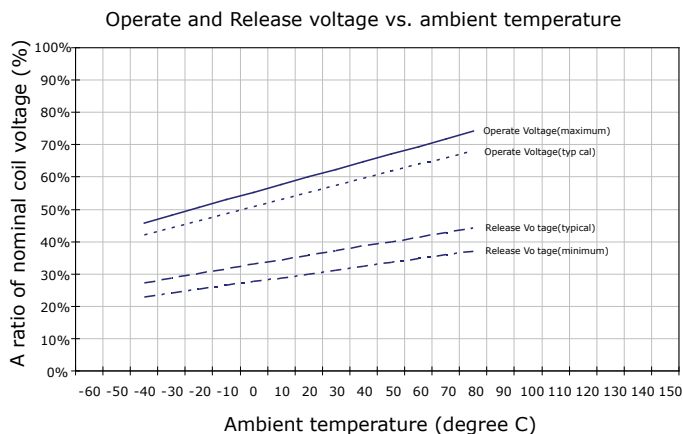

Magnetic Interference

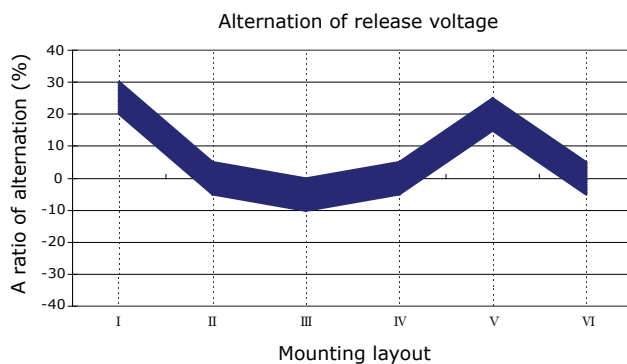
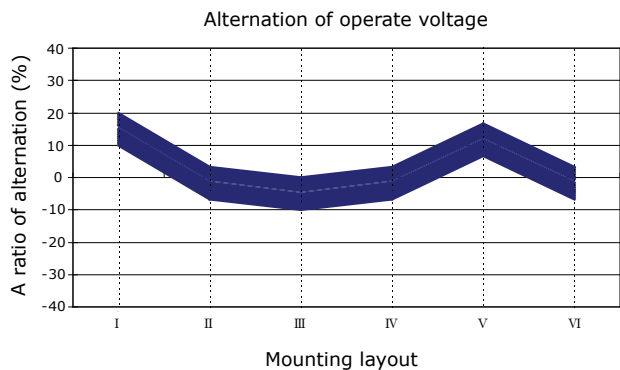

Device under test

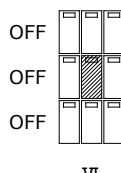
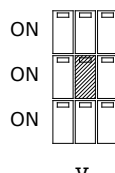
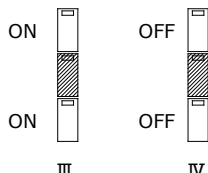
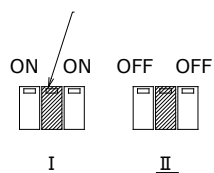

L1: 4.7mm
L2: 12.0mm

Notes: Reference data of MH-E1T05JH